

MN45

MIGNON NEW 45

AVVOLGIBILE IN ALLUMINIO COIBENTATO
con poliuretano **media densità**

Profilo in alluminio per avvolgibile a schiuma poliuretana ecologica ad alta stabilità e lunga durata.

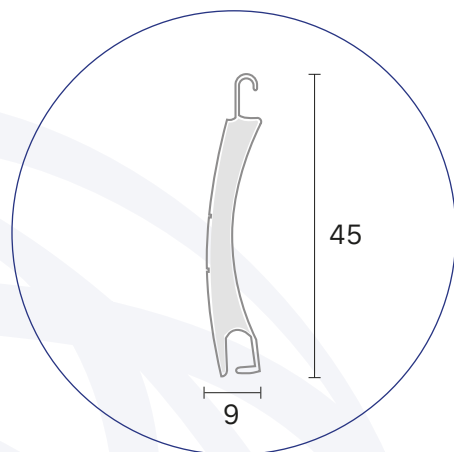
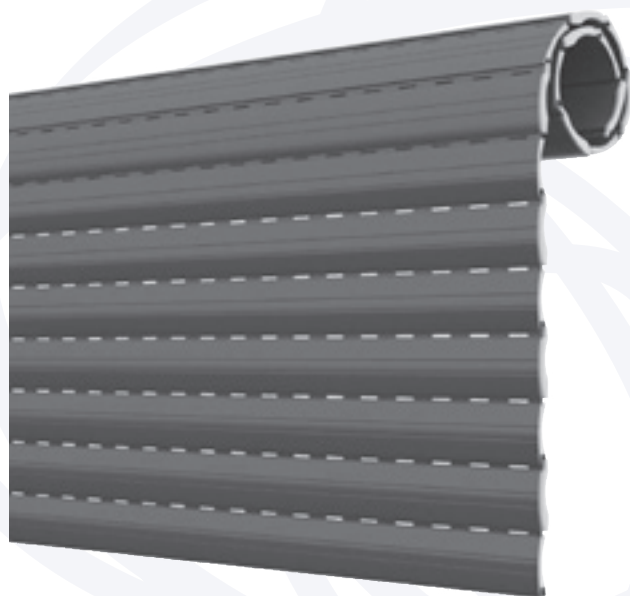

Caratteristiche tecniche

DIMENSIONE PROFILO 9x45 mm	PESO A M² ca 2,8 Kg	SPESORE ALLUMINIO 0,30 mm	BARRE PER 1 MT DI ALTEZZA 22	LARGHEZZA MAX 3500 mm
--------------------------------------	--	-------------------------------------	--	---------------------------------

DIAMETRO DI ARROTOLAMENTO

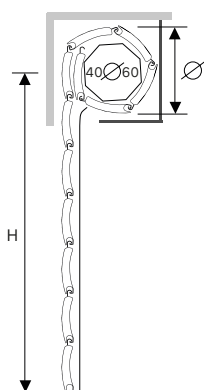

Altezza misura centro rullo 1000 | 1200 | 1300 | 1400 | 1500 | 1600 | 1700 | 1800 | 1900 | 2000 | 2200 | 2400 | 2600 | 2800 | 3000 | 3300 |

Diametro su rullo da 40 mm 115 | 125 | 130 | 130 | 135 | 140 | 145 | 150 | 150 | 155 | 160 | 165 | 170 | 175 | 180 | 185 |

Diametro su rullo da 60 mm 115 | 120 | 125 | 130 | 140 | 145 | 150 | 155 | 160 | 165 | 165 | 170 | 175 | 175 | 185 | 190 |

Ø = diam di avvolg. su rullo / Diametri calcolati con molla mini

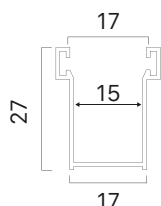

Guida alluminio 27x17 mm
con spazzolino 4,8x6

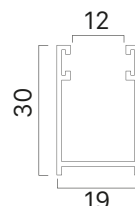

Guida alluminio 30x19 mm
con spazzolino 4,8x4

Terminali compatibili

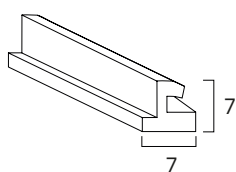

in **gomma**
7x7 mm

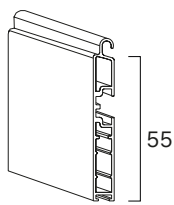

in **alluminio**
9x55 mm

Catenaccioli

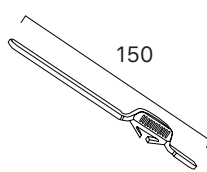

Caten. per terminale
150 mm
CATTERM

Bloccaggio stecca



Standard con **tappo laterale spillato**